

Stander Size 2 & 3

Rifton Stander Size 2 & 3

S420 & S430 Product Manual



Contents

Important information; Check your order	4
Safety messages	5
Recommended use; User and item dimensions	6
Critical supports	7
Basic item frame	8
Wheels; Height adjustment; Caregiver handle	8
Tilt adjustment; Body support; Trunk laterals	9
Strap attachment; Leg supports	10
Hip depth adjustment; Abduction; Sandals	11
Basic item PRONE	12
Trunk strap; Pelvic harness	12
Basic item SUPINE	13
Upper trunk support; Arm supports	13
Headrest; Trunk strap	14
Hip strap; Knee straps	15
Split Knee Supports	16-17
Basic item MULTI-POSITION	18
Conversion kits	18
Optional components	19
Tray; Elbow Blocks	19
Medial/lateral thigh supports; Head laterals	20
Headrest adapter plate	21
Butterfly harness; Prone knee cuffs; Prone upper trunk support	22
Operation	23
Positioning basics	23
Transfers	24-26
Prone/Supine conversion	27-28

Contents cont.

Materials	29
Maintenance	30
Cleaning; Warranty; User modifications	31
Contact information	32

IMPORTANT

Please save this product manual for future reference. Additional copies are available at www.rifton.com.

Key for users

Use this key to determine which sections of this product manual apply to you.

 **Technical Users** For professionals who order and set up Rifton products.

 **Home Users** For care-givers who use Rifton products on a regular basis.

 **Maintenance Personnel** For anyone who is responsible for service or re-ordering of Rifton products and parts.

Check your order

Your Rifton Stander comes assembled in one carton, though you may need to attach some of the components. Check that all required components and the optional components you selected are present. (You may not have ordered all of the available components.)

If your shipment is incomplete or in any way damaged on arrival, please call Customer Service, 800.571.8198.

WARNING



- Thoroughly read and understand the information in this product manual before attempting to use this product. If the procedures and instructions in this product manual are not followed, serious injury or death could occur.
- A qualified professional must assess the appropriateness and safety of all equipment for each user.
- A qualified medical professional must perform the initial set-up of the Stander, and must ensure that other caregivers are trained in correct operation.
- This product is intended for use by users of unreliable judgment. Adult supervision is required at all times.
- To prevent falls and injuries:
 - Do not use this product on rough and uneven terrain, around swimming pools, or near stairways.
 - Ensure the appropriate use of straps and supports at all times. Straps and supports are provided for the safety of the user and must be carefully adjusted for comfort and security.
 - Ensure that you use all the correct straps and supports for the specific Stander configuration (prone or supine). Refer to the labeling and this manual.
 - Tighten all adjustment knobs before use and immediately after making any adjustments.
 - Lock brakes at all times except when transporting the Stander, and lock brakes for all transfers in and out of the product.
- To prevent tipping and resulting injury:
 - Use the Stander indoors only.
 - When moving the Stander, hold the push handle firmly, move at a slow and controlled speed, and take extra care on doorsills, ramps, corners, and any uneven surfaces.
- Do not use this product for users outside the height and weight limits specified in this manual.
- To prevent structural failure, which may result in serious injury or death:
 - Inspect this product and components regularly for loose or missing screws, metal fatigue, cracks, broken welds, missing attachments, general instability or other signs of excessive wear.
 - Immediately remove this product from use when any condition develops that might make operation unsafe.
 - Do not use Rifton components or products for any purpose other than their intended use.

Recommended use

The Rifton Stander is a Class 1 medical device. It is intended to support people with disabilities in standing position, providing the health and therapeutic benefits of supported standing. The Rifton Stander allows for growth and can be configured for prone or supine standing. The multi-position configuration allows both. A variety of padded supports, straps and adjustments allow comfortable and precise positioning for users with different physical needs. Configuration and initial setup should be done by a qualified medical professional.

User and item dimensions

User dimensions – inches (cm)	Size 2	Size 3
Height	38–53 (96–135)	48–65 (122–165)
 <p>Key user dimension: height The user’s overall height is a general guide to help you select the appropriate size. Choose the model that allows for growth.</p> <p>Important: User’s weight must not exceed the maximum working load.</p>		
Item dimensions – inches (cm)	Size 2	Size 3
Base length	39 (99)	43 (109)
Base width	27 (68)	29 (73.5)
Horizontal body support height above floor	22.5–36.5 (57–93)	23.5–38 (59.75–96.5)
Sandal to knee height	10 –15.25 (25 –39)	12.25–19 (31–48)
Knee to hip height	8.5 –13.5 (21 – 34)	12–17.25 (30.5–44)
Sandal to top of headrest	41 – 55 (104 – 139)	49–66.5 (124.5–169)
Distance between trunk laterals	7 – 11.5 (18 – 29)	9–14 (23–35.5)
Distance between thigh medial and lateral support	3.25 – 5 (8 –13)	4–5.5 (10–14)
Basic item weight (Prone)	73 lbs (33 kg)	104 lbs (47 kg)
Basic item weight (Supine)	78 lbs (35.5 kg)	115 lbs (52 kg)
Max. working load in lbs (kg)	100 (45 kg)	185 lbs (84 kg)

Critical supports

⚠️ WARNING To avoid falls or strangulation, always ensure the correct straps and supports are used in each configuration. The infographic to the right shows the minimum straps and supports required for safe positioning in prone and supine standing.

These minimum supports are denoted throughout this guide by * for supine and * for prone.

Figure 6a: Straps have color coded tags. Use components with **GREEN** tags for supine positioning, and components with **BLUE** tags for prone positioning.

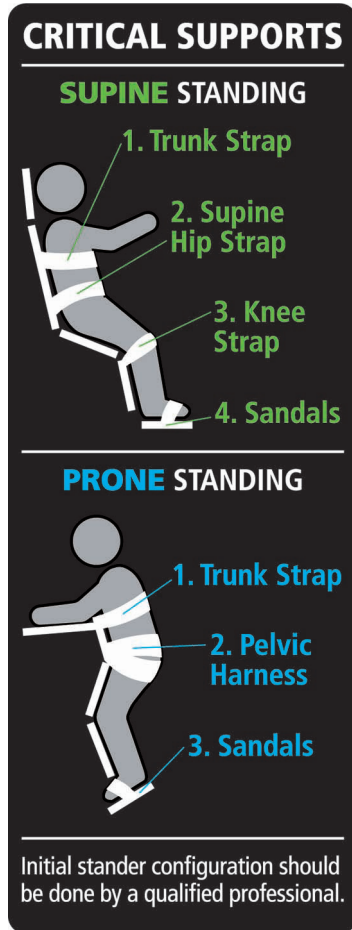

CRITICAL SUPPORTS

SUPINE STANDING

- 1. Trunk Strap
- 2. Supine Hip Strap
- 3. Knee Strap
- 4. Sandals

PRONE STANDING

- 1. Trunk Strap
- 2. Pelvic Harness
- 3. Sandals

Initial stander configuration should be done by a qualified professional.

Figure 6a

Basic item frame

⚠️ WARNING Product can tip over if used incorrectly.

Always engage brakes during transfers and standing.

Wheels / Brakes

The wheeled base has two large wheels on the side and casters at the front and rear for excellent maneuverability. When the Stander is loaded, the rear caster is intentionally raised slightly off the floor, which helps when negotiating doorills or uneven floors. Foot operated brakes are located on both of the large wheels.

Figure 8a: Press down on the white pedal to lock brake, kick forward on the top tab to release.



Figure 8a

Height adjustment

The column allows 14 inches of height adjustment using a hand crank.

Figure 8b: Use crank to adjust the body support height as needed for transfers or different sized users.



Figure 8b

Caregiver handle

Use the caregiver handle for steering and pushing the Stander, as well as for adjusting the body support angle.

Figure 8c: Adjust the handle position using the knob (A) at the attachment point. Always ensure the handle adjustment knob is tight before changing the body support angle or moving the Stander.

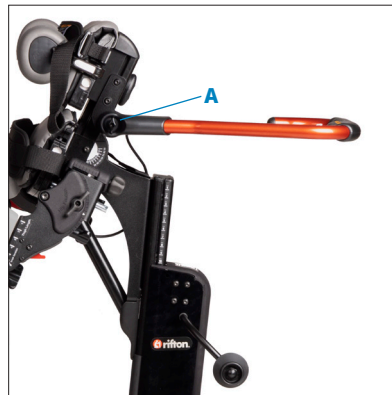

Figure 8c

Tilt adjustment

⚠️ WARNING To prevent falls or other injury, ensure all straps are secure and knobs tight before tilting user to a standing position.

The body support can be adjusted from horizontal to completely vertical (90°).

Figure 9a: Grasp the caregiver handle firmly and squeeze the double trigger to adjust the body support angle. Release the triggers to lock the adjustment.



Figure 9a

Body support

Figure 9b: The padded body support has two sections; the hip support remains stationary and the trunk support height can be adjusted using the central knob on the back.

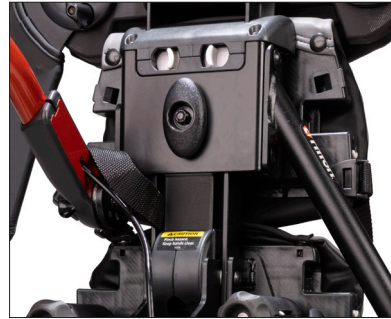

Figure 9b

Trunk laterals

Trunk laterals may be used at the trunk, at the pelvis, or in both positions if a second pair of laterals was selected.

Figures 9c and 9d: Use the white triggers (A) on the side of the body support for width adjustment or removal. Use the knob (B) to adjust the height of each lateral pad, and use the white trigger (C) to swing lateral away for ease of transfer.



Figure 9c

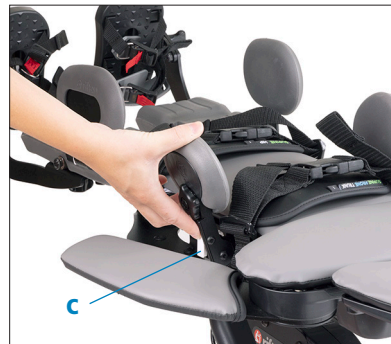

Figure 9d

Strap attachment

All straps on the body support attach with similar clips.

Figure 10a: Insert the tip of the clip into corresponding socket behind the body support and pull forward until it clicks. Pull the clip back away from the pad to remove the strap.



Figure 10a

Leg supports - standard

Figure 10b: The leg support has one pad centered on the thigh and another for the lower leg. Adjust the thigh length using the knob (A) behind the thigh pad; read the position on the indicator scale on the outside of the metal piece. Adjust the lower leg length using the knob (B) behind the pad and read the position on the indicator provided there.

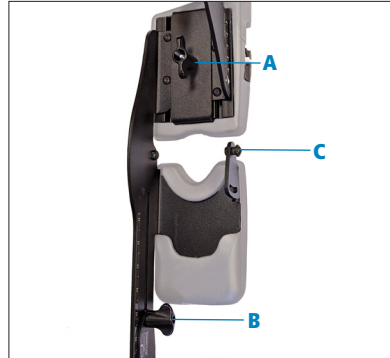

Figure 10b

NOTICE

The center of the user's knee should line up with the strap attachment posts (C).

Leg supports - advanced

The advanced leg supports have the same adjustments for thigh length and lower leg length described above. In addition, hip flexion and knee flexion may be adjusted in a 0-45° range for either prone or supine standing positions.

Figure 10c: Adjust hip flexion using the knob (D) toward the outside of the hip. To adjust beyond the neutral position and allow the leg support to move into the prone standing range, pull the red trigger (E).

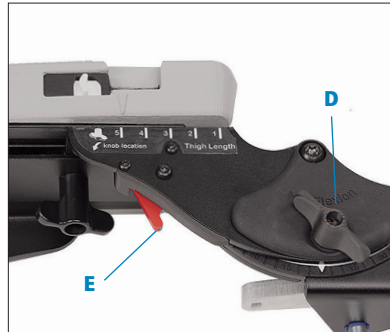

Figure 10c

Figure 10d: Adjust the knee flexion angle using the knob (F) behind the knee.

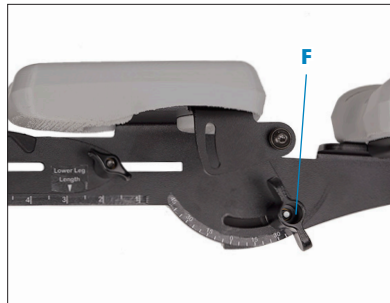

Figure 10d

Hip depth adjustment

Figure 11a: Adjust the hip depth, moving the whole leg support forward or back relative to the body support by turning the knob (A) behind the hip support pad. Read the position on the indicator (B) near the knob.

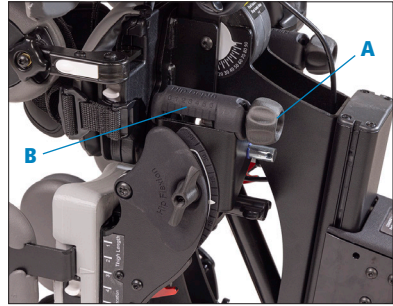

Figure 11a

Abduction

The Rifton Stander provides independent abduction up to 30° for each leg.

Figure 11b: Loosen knob (C) behind the hip joint to adjust hip abduction.

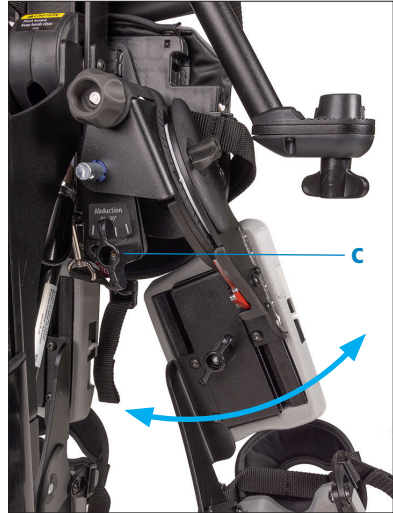

Figure 11b

Sandals

The sandals have adjustable heel cups and straps with buckles to position and secure the feet.

Figure 11c: Loosen the knob (D) underneath the sandal to rotate the sandal or adjust it forward and back. Use the knob (E) toward the inner side of the sandal to adjust the ankle plantar flexion/dorsiflexion through a total of 30°. Rotate the sandal 180° to switch between prone and supine configuration.

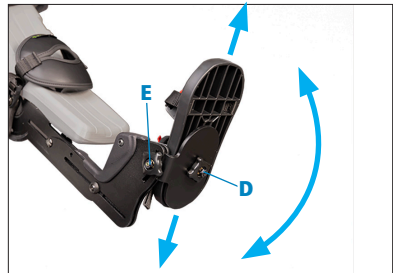

Figure 11c

Basic item PRONE

See pages 8–11 for base frame, body support, leg, sandal, and height adjustments.

Trunk strap*

⚠️ WARNING To prevent falls or other injury, all users should be secured with a trunk strap (standard or rotation control) in prone standing.

A trunk strap (standard or rotation control) stabilizes the trunk and is required for prone standing.

The padded trunk strap attaches under the arms and securely positions the upper body.

Figure 12a: To attach the trunk rotation control strap, detach the top end of the trunk pad and slide the webbing loop down behind the pad. Re-attach the trunk pad, then clip the ends of webbing strap to the body support. Close the strap snugly around the user, then close the buckle and tighten either side to control trunk rotation.



Figure 12a



Figure 12b

Pelvic harness*

⚠️ WARNING To prevent strangulation or other injury, in prone standing the prone pelvic harness **MUST** be used with all five attachment points secured.

In prone standing the pelvic harness provides critical support behind the user's hips to maintain the standing position. This is a shaped, padded harness, with a 5-point attachment system for safety.

Figure 12b: Tighten lower straps first to secure the harness low under the user's hips and provide ideal support. Then secure the remaining straps and adjust until snug. Use the three buckles on the right side and center when transferring the user in and out.

NOTE: For Size 3 in Prone use, the Prone Upper Trunk Support is recommended. See page 22.

Basic item SUPINE

See pages 8–11 for base frame, body support, leg, sandal, and height adjustments.

Upper trunk support

The upper trunk support includes head and arm support and attaches to the top of the body support.

Attaching

Figure 13a: To attach the upper trunk support, tilt it back 45° from the plane of the body support and insert stampings into slots.

Squeeze white triggers so the stampings slide down and latch in.

Adjusting

Figure 13b: Squeeze the white triggers to adjust the upper trunk support height. It should be adjusted near the top of the user's shoulders, although it is fine for smaller users to end up lower on the pad.

Arm supports

Figure 13c: The padded arm supports are mounted permanently on either side of the upper trunk support. They provide support behind the arms in supine positions. A knob (A) behind the attachment point allows each arm support to swing up out of the way behind the headrest during transfers.



Figure 13a

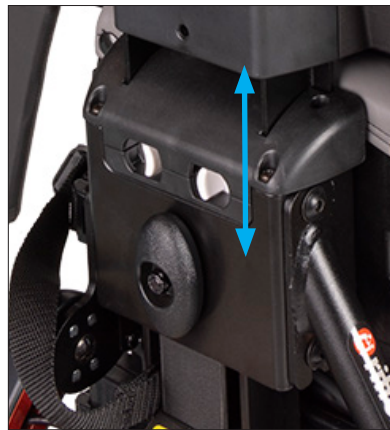

Figure 13b



Figure 13c

Headrest

Figure 14a: The headrest is attached to the upper trunk support and provides posterior support for the user's head. Adjust the headrest forward and back using the knob (A) behind it. Attach optional head laterals for additional support (see p. 17).

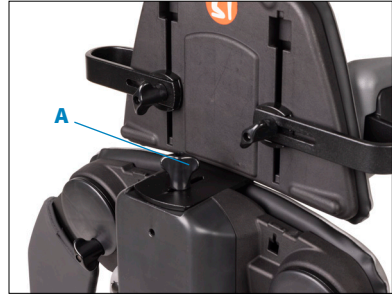

Figure 14a

Trunk strap*

⚠ WARNING To prevent falls or other injury, all users should be secured with a trunk strap (standard or rotation control) or butterfly harness in supine standing.

A trunk strap (standard or rotation control) securely positions and stabilizes the trunk. For additional upper trunk positioning and stabilization, a butterfly harness may be used in supine standing. See p. 19 for full instructions and important safety information.

A trunk strap (standard or rotation control) or a butterfly harness is required for supine standing.

Figure 14b: The padded trunk strap attaches under the arms and securely positions the upper body.



Figure 14b

Figure 14c: To attach the trunk rotation control strap, detach the bottom end of the trunk pad and slide the webbing loop up behind the pad. Re-attach the trunk pad, then clip the ends of webbing strap to the body support. Close the strap snugly around the user, then close the buckle and tighten either side to control trunk rotation.



Figure 14c

Supine hip strap* SUPINE ONLY

A hip strap (standard or rotation control) is required for supine standing.

Figure 15a: The padded supine hip strap provides support around the hips and positions the user securely on the body support.



Figure 15a

Figure 15b: To attach the hip rotation control strap, detach the bottom end of the trunk pad and slide the webbing loop up behind the pad. Re-attach the trunk pad, then clip the ends of webbing strap to the body support. Close the strap snugly around the user, then close the buckle and tighten either side to control trunk rotation.



Figure 15b

Knee straps*

⚠ WARNING To prevent strangulation or other injury, in supine standing the user's knees **MUST** be secured with knee straps or split knee supports.

Figure 15c: The individual padded knee straps clip onto the leg supports at either side of each knee with a keyhole type attachment onto the posts (A) provided. These knee straps have an opening at the patella for user comfort, and may be tightened securely by pulling the strap ends. The posts on the sides of the leg supports should align with the user's knees for correct strap placement.



Figure 15c

Loosen the strap by lifting the plastic tab on the attachment clip and unclip one end from the post to release the strap completely.

Split Knee Supports*

SUPINE ONLY

Installation

Figure 16a: Remove the fabric supine knee straps if present. Attach the split knee supports by hooking the keyhole over the mounting post on the lateral side of the leg and sliding it down onto the stud. Slide the mounting bolting from behind the leg through the angle slot and through the hole in the split knee stamping and attach the knob provided



Figure 16a

Adjustment and Use

Figure 16b: Position the two padded foam hoops above and below the users knee. Knob (A) also allows angle adjustment to align the support centered on the knee.



Figure 16b

Figure 16c: Adjust the knee support position forward and back, using the knob on top at the rear (B).



Figure 16c

Figure 17a and 17b: Flip the knee support out to the side for transfers by firmly pushing in and holding the white release latch (A). To apply the knee support again, flip it in until you hear the click of the latch.



Figure 17a



Figure 17b

Basic item MULTI-POSITION

The multi-position option has all the features and components of both Prone and Supine Stander described above and may include any of the optional components selected as well. The multi-position option enables both prone and supine configurations.

Your device can be upgraded from a prone or supine stander to a multi-position stander with the appropriate conversion accessories.

PRONE to MULTI-POSITION

Figure 18a This option will upgrade a Prone Stander to the multi-position Stander by adding the functionality of supine standing. This can include the upper trunk support with attached headrest and arm supports, a supine hip strap, (standard or rotation control or butterfly harness), and a pair of supine knee straps or split knee supports.

SUPINE to MULTI-POSITION

Figure 18b: This option will upgrade a Supine Stander to the multi-position Stander by adding the functionality of prone standing. This adds the prone pelvic harness to the product, as well as optional components such as the prone upper trunk support on Size 3, and the prone knee cuffs.

See the website, or call Rifton to find out exactly which options you will need to upgrade your stander.



Figure 18a



Figure 18b

Optional components

Tray

Attaching

Figure 19a: The tray has a single mounting point at the side of the Stander, and may be used in either Prone or Supine standing. To attach the tray, insert the bolt on the tray arm into the socket at the side of the Stander. Push the knob (A) up and turn to tighten.

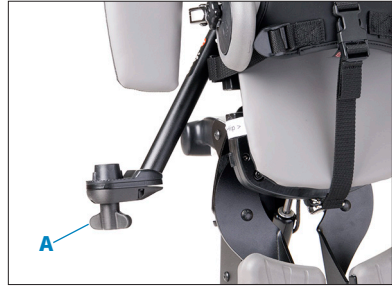

Figure 19a

Adjusting

Figure 19b: Adjust the tray position easily by loosening all 3 knobs that face downward and moving tray to the desired position before tightening the knobs again. The knob (B) under the center of the tray also allows tray angle adjustment. To adjust the tray height use the knob (C) that faces forward.



Figure 19b

Elbow blocks

Attaching

Figure 19c: Elbow blocks have a single mounting point on either side of the tray. Slide elbow blocks into place until they latch to the underside of the tray.



Figure 19c

Figure 19d: To remove an elbow block, squeeze trigger tips together and slide off the tray.



Figure 19d

Medial/lateral thigh supports

One or two pairs of thigh support pads may be used. When used at the medial thigh they provide an abductor function. Mount the medial/lateral thigh supports on the inside for medial support, or on the outside for lateral support.

Figure 20a: Adjust the width using the white trigger (A). The mounting bracket is off-center, so the pad has two possible height positions. Swap pads to change height position.

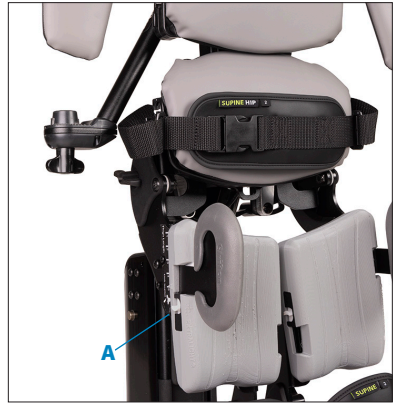

Figure 20a

Head laterals

Figure 20b: Add a pair of head laterals for additional head support and control. To attach, insert at the top of the slot and slide down to desired position. Loosen the knob (B) to adjust independently in height and width.



Figure 20b

Headrest adapter plate

Figure 21a: For customers wishing to mount a different headrest on the Size 2 Rifton Stander, we offer an Adapter Plate. This fits the Whitmyer M2100-WB headrest mounting bracket or Whitmyer Onyx Headrest Support System, the Stealth SBM300, as well as other similar mounting systems.

Figure 21b: Remove the Rifton headrest by taking off the center knob completely. Push the bolt down into the slot provided.

Figure 21c Remove the pad from the upper trunk support, Insert the bolts through the washers, and through the two holes in the plastic.

Figure 21d Tighten the bolts into the plate using a 3/16" hex tool. Re-attach pad to upper trunk support.

NOTICE

The customer assumes full responsibility that this field modification is correctly and safely completed. Rifton does not recommend or guarantee that another manufacturer's headrest will safely satisfy the needs of the customer. Rifton is not responsible for the installation or safe use of another manufacturer's products.



Figure 21a



Figure 21b



Figure 21c



Figure 21d

Butterfly harness

⚠ WARNING To prevent strangulation, always attach center safety strap and make sure all straps are snug before every use.

Figure 22a: In supine standing a butterfly harness may be used in place of a trunk strap. The butterfly harness provides more upper trunk positioning and stabilization. For safety, always use all five attachment points.



Figure 22a

Prone knee cuffs PRONE ONLY

Figure 22b: Prone knee cuffs are available for prone standing only. They wrap around the user's knee and give some medial/lateral stabilization of the knee on the padded leg support. They are also useful for preventing knee hyperextension when necessary.

In addition, some degree of rotational control can be achieved by tightening the strap on one side of the cuff more than the other.



Figure 22b

Prone upper trunk support (Size 3) PRONE ONLY

Figure 22c: The Prone Upper Trunk Support offers additional security and support for the user's upper body. It is designed to comfortably accommodate different body shapes including larger female users. It has sockets for attaching a high trunk support if desired.



Figure 22c

Operation

The Rifton Stander is intended to allow users who may be unable to stand independently to be positioned safely in prone or supine standing, up to fully vertical as needed. Review the following positioning and transfer information for proper operation of this Stander, and also refer to the safety information on page 5 of this product manual.

Positioning basics

Figure 23a: To position the user at the correct height in the stander, align their hips with the “HIP” tags (A) on either side of the body support. Remember that the user may tend to sink down slightly in the stander when it is tilted toward vertical, so it may help to position them slightly higher to begin with.



Figure 23a

When adjusting leg length or upper trunk support height to fit the user, ensure that the user’s hips remain in line with the “HIP” tags.

Figure 23b: For correct alignment of the leg pads and knee straps, the user’s knee should line up with the strap attachment posts (B) on either side.



Figure 23b

To position the pelvic harness correctly in prone, tighten the lower side straps first to get the support low and tight under the hips and comfortably support the user’s weight.

Check for any pressure areas and adjust the supports to relieve them. You may need to move the sandals forward or back to get the leg comfortably supported against the leg pad.

Transfers

Follow these steps for easy transfer into the Stander:

⚠️ WARNING To avoid injury, always observe safe lifting and handling procedures. For transfers involving larger users consider getting assistance from a second caregiver, and consider using a mechanical lift for supine transfers.

Prone transfer 1 (sit-to-stand transfer)

Figure 24a:

- 1: Measure from the center of the user's knee to the the bottom of their foot and set lower leg length on the Stander to match.
- 2: Measure from the center of the user's hip to the center of their knee and set thigh length on the Stander to match.
- 3: Position the Stander close to the user with the body support nearly vertical. Lock the brakes.
- 4: Place the user's feet on the sandals, legs against the pads.
- 5: Help the user to stand up and secure the pelvic harness.
- 6: Apply the other straps and supports, and secure the sandal straps.
- 7: Check that minimum required supports for prone standing are secure:
 - Trunk strap (standard or rotation control)
 - Pelvic harness – 5 straps
 - Sandals
8. Adjust to desired angle for standing.



Figure 24a

Prone transfer 2 (lifting transfer)

NOTE: This transfer method is only appropriate for smaller users.

Figure 25a:

- 1: Measure from the center of the user's knee to the bottom of their foot and set lower leg length on the Stander to match.
- 2: Measure from the center of the user's hip to the center of their knee and set thigh length on the Stander to match.
- 3: Adjust the stander to horizontal or near horizontal and lock the brakes.
4. Lift the user into the stander and secure the pelvic harness.
5. Apply the other straps and supports and secure the sandal straps.
6. Check that minimum required supports for prone standing are secure:
 - Trunk strap (standard or rotation control)
 - Pelvic harness – 5 straps
 - Sandals
7. Adjust to desired angle for standing.



Figure 25a

Supine transfer

NOTE: Consider if a mechanical lift is required, especially for transferring larger users.

Figure 26a:

- 1: Measure from the center of the user's knee to the bottom of their foot and set lower leg length on the Stander to match.
- 2: Measure from the center of the user's hip to the center of their knee and set thigh length on the Stander to match.
- 3: Position the Stander horizontal at the desired height for transfer. Lock the brakes.
4. Open the straps and swing the laterals out of the way.
5. Lift the user onto the Stander and align hips with the hip markers on the Stander. Secure the hip strap first.
6. Adjust thigh and lower leg length if necessary.
7. Ensure the posts on the sides of leg supports align with user's knees for correct strap placement. Secure the knee straps or split knee supports.
8. Apply the other straps and supports and secure the sandal straps.
9. Check that minimum required supports for supine standing are secure:
 - Trunk strap (standard or rotation control) or butterfly harness
 - Supine hip strap (standard or rotation control)
 - Knee straps or split knee supports
 - Sandals
10. Adjust to desired angle for standing.



Figure 26a

PRONE / SUPINE conversion

Multi-Position Stander only

It is very important to configure the product correctly and to ensure that the correct straps and supports are used in each position. Straps have color coded tags. Use components with **GREEN** tags for supine positioning, and components with **BLUE** tags for prone positioning.

Switching to PRONE

1. Remove upper trunk support

Squeeze the triggers on the back of the trunk support. Pull the upper trunk support up and tilt it back to remove it. For Size 3 add the prone upper trunk support if desired.

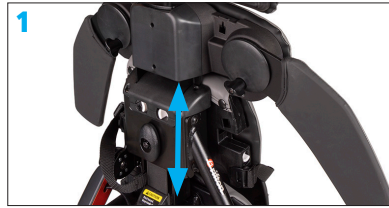

2. Switch tray direction

If the tray is used, loosen attachment knob (A), remove the tray and attach it facing the other direction. For use in prone, adjust the tray up and the caregiver handle down and out of the way.



3. Switch to pelvic harness

Remove the supine hip strap. Install the pelvic harness by attaching all 5 straps.



4. Remove knee straps OR split knee supports.

Optional prone knee cuffs may be added.



5. Rotate sandals 180°

Loosen the knob (B) under the sandal, rotate them so that heel cups are towards the front of the stander, and tighten the knob.

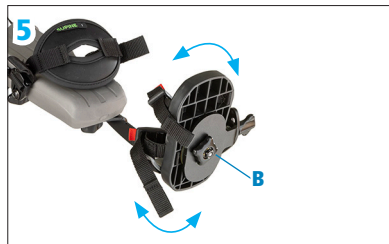

Adjust leg supports appropriately for the prone position.

6. Adjust leg supports

Adjust hip flexion and knee flexion if using the advanced leg supports.



Switching to SUPINE

1. Add upper trunk support

For Size 3 if the prone upper trunk support is present, remove it first. Tilt the upper trunk support back 45° from the plane of the body support and insert the stampings into the slots. Squeeze the triggers on the back of the body support to adjust the upper trunk support down to the desired position.

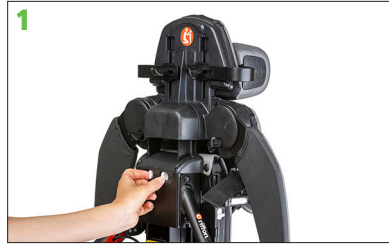

2. Switch tray direction

If the tray is used, loosen attachment knob (A), remove the tray and attach it facing the other direction.



3. Switch to supine hip strap

Remove the pelvic harness at all 5 attachment points. Install the supine hip strap (standard, or rotation control).



4. Add knee straps or split knee supports.

Clip the knee straps onto the posts on either side of the knee.



5. Rotate sandals 180°

Loosen the knob (B) under the sandal, rotate them so that the heel cups are towards the back of the stander, and tighten the knob.

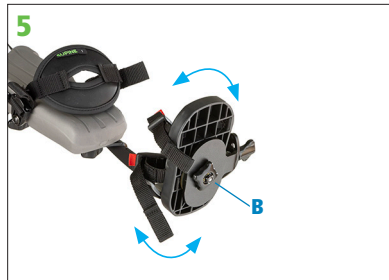

Adjust leg supports appropriately for the supine position.

6. Adjust leg supports

Adjust hip flexion and knee flexion if using the advanced leg supports.



Materials

- Steel hardware items (nuts, bolts, screws, etc) are typically zinc or nickel plated, or stainless steel.
- Upholstery items (pads on the body support) are polyurethane foam with a fire-retardant cover.
- Other padded supports are made of molded cross-linked polyolefin foam.
- Frames are welded steel tubing coated with a baked-on paint finish. Some frame components are aluminum extrusions.
- Wheels have solid tires and do not require inflation.
- Straps are typically made of polypropylene webbing with laminated foam padding.
- Plastic components are typically injection molded from a variety of industrial resins.

All materials are latex, lead and phthalates free.

Cleaning

The Stander can be cleaned with disinfectant wipes or a solution of up to 10% bleach. Do not use excessive amounts of water. This includes metal parts, upholstery, harnesses and padded straps. You may also use a commercial cleaning agent suitable for imitation leather for the upholstery.

Do not machine wash harness or padded straps.

Warranty statement

If a Rifton product breaks or fails in service during the first year, we will replace it free of charge.

User modifications

⚠️ WARNING To prevent serious injury or death, do not modify or alter Rifton products or components, or use Rifton products or components in conjunction with products from other manufacturers. Rifton does not accept responsibility for any modifications or alterations made to our components or products after they leave our premises. Customers modifying or altering our components or products, or using them in conjunction with products from other manufacturers, do so at their own risk.

Rifton Contact Information



Email

Sales@Rifton.com



Phone

800.571.8198
9–5 EST



Mail

Rifton Equipment
PO Box 260
Rifton NY 12471–0260



Fax

800.865.4674



Online

www.Rifton.com

To order replacement parts

1. **Locate the ID number** of the product on the small white label.
2. Have this number available when you call **800.571.8198** for your customer service representative.

Use only replacement parts supplied by Rifton Equipment.

We are glad to supply replacement parts throughout the 8 year expected life of the product. Although Rifton makes every effort to supply correct parts and instructions for repairing or refurbishing your equipment, you are responsible to make sure that the repairs or modifications are correctly and safely completed.



Find letters of medical necessity and studies on the therapeutic benefits of standing at:
www.rifton.com/newstander