

# Rifton Blue Wave Bathing System

## Sample Letter of Medical Necessity



EVERY REASONABLE EFFORT HAS BEEN MADE TO VERIFY THE ACCURACY OF THE INFORMATION. HOWEVER, THE SAMPLE LETTERS OF MEDICAL NECESSITY ARE NOT INTENDED TO PROVIDE SPECIFIC GUIDANCE ON HOW TO APPLY FOR FUNDING FOR ANY PRODUCT OR SERVICE. HEALTH CARE PROVIDERS SHOULD MAKE THE ULTIMATE DETERMINATION AS TO WHEN TO USE A SPECIFIC PRODUCT BASED ON CLINICAL APPROPRIATENESS FOR A PARTICULAR PATIENT AND APPLICATIONS TO ANY FUNDING SOURCE MUST ACCURATELY REFLECT THE FACTS UNIQUE TO INDIVIDUAL APPLICATIONS. THIRD PARTY PAYMENT IS AFFECTED BY NUMEROUS FACTORS AND RIFTON CANNOT GUARANTEE THE SUCCESS IN OBTAINING INSURANCE OR THIRD PARTY PAYMENTS OF ANY KIND.



**Rifton Equipment**  
PO Box 260  
Rifton, NY 12471

**800-571-8198**

**Fax:** 800-865-4674

**www.rifton.com**

# Rifton Blue Wave Bathing System

## Components of a letter of Medical Necessity

### **Describe who you are, what you want, and beneficiary's name:**

As John Doe's therapist, I am requesting funding authorization for a Rifton Blue Wave Bathing System.

### **Explain beneficiary's condition, diagnosis, or nature of injury:**

John Doe has \_\_\_\_\_ and is currently (describe ability to sit, stand, and walk including amount of assistance needed for each activity pertinent to the piece of equipment).

### **Discuss the impact of the above diagnosis on the beneficiary's and caregiver's life. Note the limitations *without* the requested equipment:**

Finding a bathing system that meets the needs and safety issues of both caregivers and significantly involved children presents a multitude of challenges and is further complicated when taking into consideration a variety of bathroom sizes and configurations. The incidence of injury is significantly higher in this area of care because of these obstacles. What follows is a breakdown of needs, safety factors and space management issues.

### **Discuss the needs and safety factors for children/adults with significant support needs. Include the benefits the requested equipment will provide:**

A bathing system must offer supports for head, trunk, hips and legs as needed for safety while allowing for freedom of movement so the child can learn self help skills in the area of personal hygiene. The system must also allow for opportunities to learn stand, pivot transfers as the child grows and develops self-management skills. To further accommodate for growth, a system must allow progression from tub to shower.

### **Describe needs and safety factors for caregivers:**

To prevent back injury, caregivers must have an environment conducive to level transfers with adequate room to maneuver themselves, a wheelchair, the child or adult and the equipment used for bathing or toileting. All of this must be done without the supportive use of clothing and is further complicated by the slipperiness of soap and water. In addition to this, as children grow, caregivers and/or family members are at a greater risk of injury due to increasingly difficult transfers.

Funding for the Rifton Blue Wave Bathing System is being requested for John Doe as this system offers solutions to the multitude of problems discussed above and more.



**Rifton Equipment**  
PO Box 260  
Rifton, NY 12471

**800-571-8198**

**Fax:** 800-865-4674

**www.rifton.com**

### Describe equipment and its adjustments for growth:

The Blue Wave Bathing System includes a bath chair, tub stand and shower stand. The tub stand and shower stand can be used with any size of bath chair. The bath chair folds for easy storage.







The bath chair has a blue cover that is removable and washable. The cover is available in standard vinyl-covered nylon, or soft polyester knit fabric. The seat fabric can be easily slipped off the frame so the user can safely sit on the floor of the bathtub. The bath chair includes supports for head, chest, hips, and legs. These supports can be released for freedom of movement as appropriate.

The bathing chair adjusts from sitting to reclining and can be used outside the bathroom as a supportive seating system in other environments. This offers John Doe a safe alternative seating option out of the wheelchair. One piece of equipment with a dual purpose makes the Blue Wave Bathing System cost-effective.

To manage the problem of transfers, the Blue Wave Bathing System has a snap-on, height adjustable tub stand that can be adjusted while the child is in the bath chair. The height of the bath chair can be adjusted to a comfortable height for the caregiver or level with a wheelchair for ease of transfers to the tub area.

Because of this height adjustability, John Doe will have opportunities to learn to assist with stand, pivot transfers as he grows.

### Itemization of the Blue Wave Bathing System

Item #	Description	Medical Necessity	Cost
E514 	<b>Small Bath System standard fabric</b>	Includes chest, waist, and leg straps for positioning and safety.	
E513 	<b>Small Bath System soft fabric</b>	Includes chest, waist, and leg straps for positioning and safety.	
E517 	<b>Tub stand</b>	Snaps on to bath chair for height adjustability to allow ease of transfers from wheelchair.  Accommodates small, medium, or large bath chair.	
E518 	<b>Shower stand</b>	Puts chair on wheels at caregiver's standing height.  Accommodates small, medium, or large bath chair.	
E544 / E545 	<b>Head blocks standard / soft fabric</b>	Provide lateral support and positioning for the head.	
E567 / E587 	<b>Additional chest strap standard / soft fabric</b>	Positioning strap adjusts securely around torso to provide comfortable trunk support.	



**Rifton Equipment**  
PO Box 260  
Rifton, NY 12471

**800-571-8198**

**Fax:** 800-865-4674

**www.rifton.com**

**Make the person real and discuss psychological benefits as well as benefits to caregiver:**

By being able to actively participate in his own care, John Doe will learn the basic living skills of personal hygiene that will help him achieve a greater sense of independence and dignity. If these needs are met, John Doe will be happier, healthier, and better able to benefit from his home and school environment.

This also passes on tremendous benefits to his caregivers. As John Doe becomes more independent with his care, and better able to assist with transfers, the caregivers' risk factors are reduced significantly.

The Blue Wave Bathing System will help fulfill John Doe's need for security and freedom of movement to develop the skills necessary for him to be the best he can be as he grows into adulthood.

**Reiterate and summarize the cost benefits:**

Toileting and bathing involve the most difficult tasks for families and caregivers of persons with significant support needs.

The tub stand and shower stand enable progression from the tub to the shower. These Stands will accommodate any bath chair size needed by the growing user.

The adaptability, adjustability, and compactness of the Blue Wave Bathing System takes all the obstacles presented in the bathroom environment into consideration and lowers the risk of injury to caregivers. This potentially lowers costs to the insurer of future injury claims.

Because the Blue Wave Bathing System accommodates for growth and can be used as an alternative floor positioning/seating device, the efficacy of this equipment makes this system most desirable for the beneficiary and the insurer.

Taking the above factors into consideration, I feel that the Blue Wave Bathing System will not only meet the needs of John Doe, his family, and his caregivers, but also be most cost-effective to the insurer.

**Don't forget to include pictures of the Blue Wave Bathing System.**



Bath Chair with Soft fabric  
and Tub Stand



Bath Chair with Standard fabric  
and Shower Stand

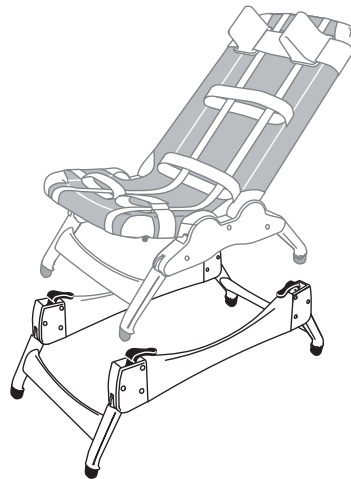
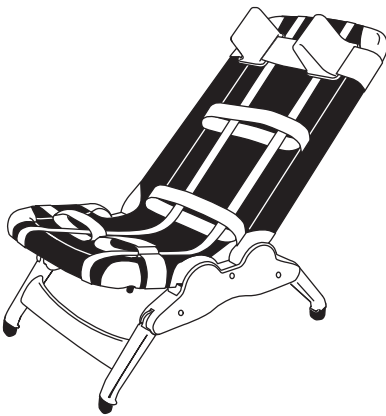

- Small Bath Chair Standard Fabric E514
- Medium Bath Chair Standard Fabric E524
- Large Bath Chair Standard Fabric E534
- Small Bath Chair Soft Fabric E513
- Medium Bath Chair Soft Fabric E523
- Large Bath Chair Soft Fabric E533

**Tub Stand** E517

**Shower Stand** E518